

COUNTERWEIGHT

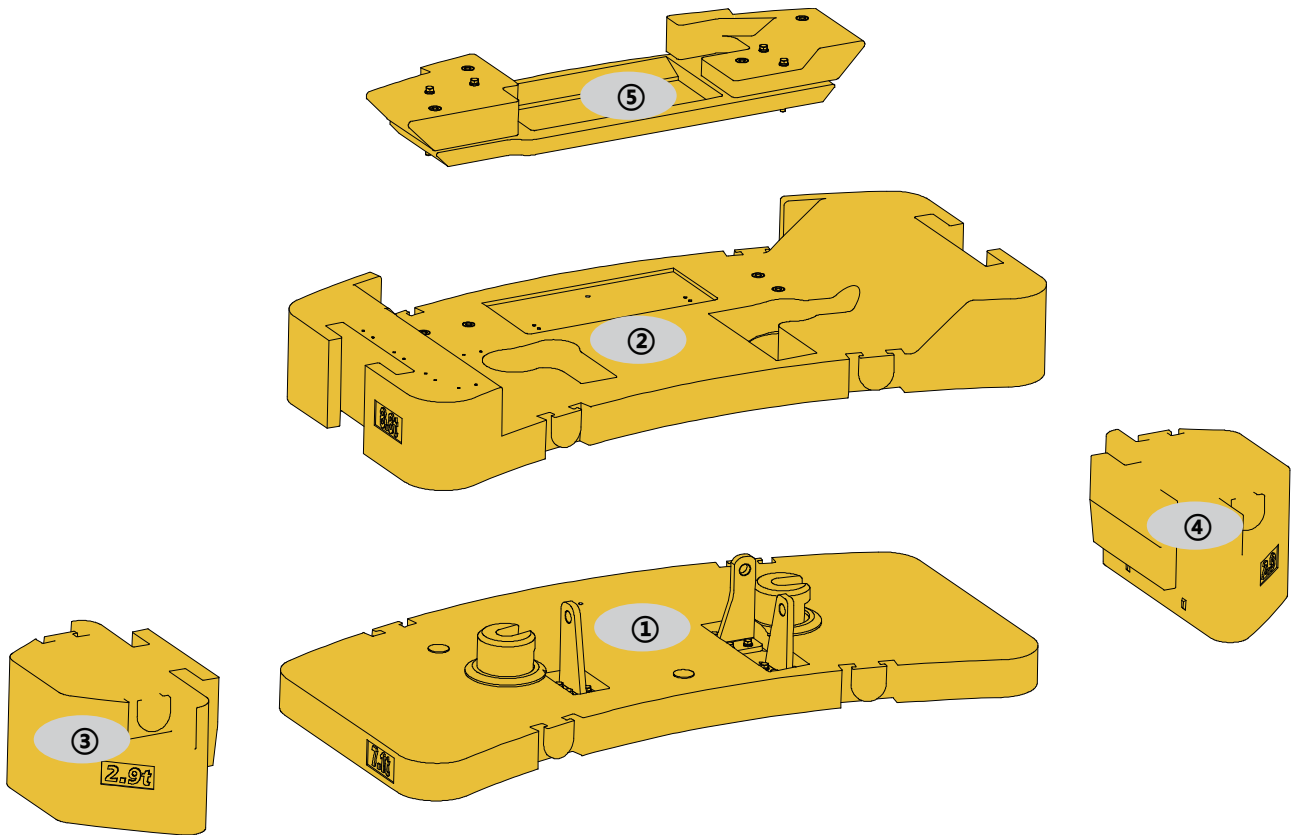

	①	②	③	④	⑤
Dimensions (L×W×H) ft (mm)	11.4 × 6.3 × 1.9 ft (3,480 × 1,850 × 570 mm)	11.4 × 6.3 × 1.5 ft (3,480 × 1,850 × 455 mm)	4.1 × 2.6 × 2.1 ft (1,241 × 787 × 655 mm)	4.1 × 2.6 × 2.1 ft (1,241 × 787 × 655 mm)	8.1 × 2.4 × 0.8 ft (2,475 × 720 × 256 mm)
Weight lb (t)	15,874 (7.2)	19,400 (8.8)	6,393 (2.9)	6,393 (2.9)	2,646 (1.2)

OPERATION MODE	50,706 lb (23 t)	35,274 lb (16 t)	0 T (0 LB)
Combinations	① + ② + ③ + ④ + ⑤	① + ②	—

BOOM	BOOM+ 1ST FIXED JIB	BOOM+ 2ND FIXED JIB
42.3-164.0 ft (12.9-50 m)	T: 164 ft (50 m) F: 35.4 ft (10.8 m)	T: 164 ft (50 m) F: 60.0 ft (18.3 m)



WORKING RANGE DIAGRAM

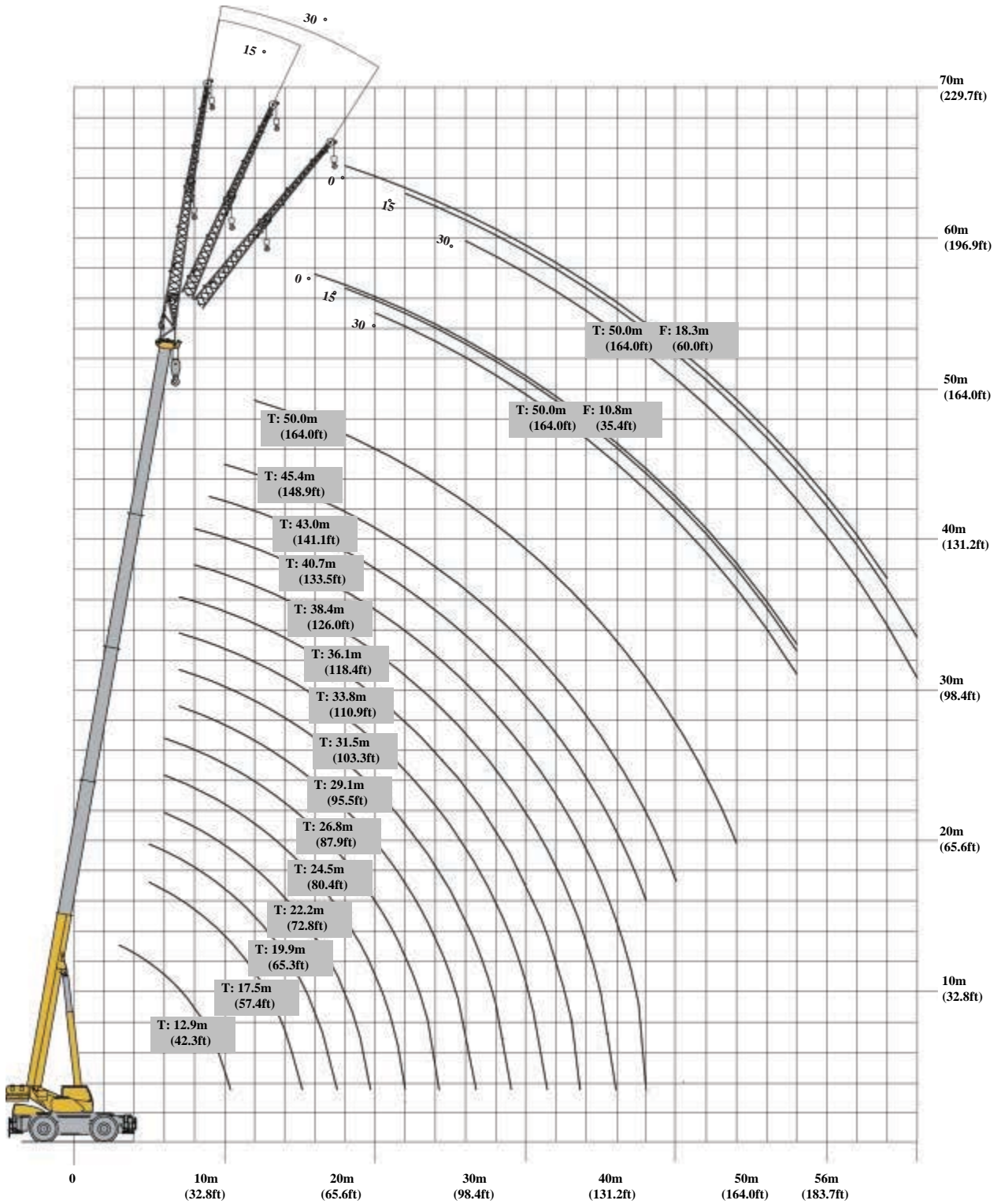

BOOM

ASME B30.5 85%

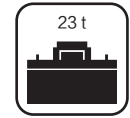
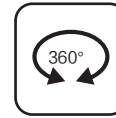

	12.9	17.5	19.9	22.2	24.5	26.8	29.1	31.5	33.8	36.1	38.4	40.7	43.0	45.4	50.0	
2.5	117*															2.5
3	110.0															3
4	90.0															4
5	72.0	70.0	39.2													5
6	60.0	59.5	40.3	56.0	37.5	39.2										6
7	52.0	52.0	41.3	52.0	38.6	40.0	37.0	30.1	28.0	31.0						7
8	45.5	45.5	42.3	45.0	39.1	37.5	37.0	30.5	26.3	30.5	22.5	20.6				8
9	39.0	40.3	40.0	39.6	40.1	35.2	35.0	28.0	24.7	27.5	21.6	19.8	19.5			9
10	28.5	35.1	34.8	34.5	35.5	33.1	31.0	26.5	23.4	27.6	20.4	18.7	18.9	17.4		10
12		25.3	27.5	25.6	28.3	28.7	27.0	22.4	21.2	24.4	18.5	17.2	17.3	17.0	13.9	12
14		19.1	21.2	19.0	21.2	22.1	20.2	21.3	19.2	21.1	16.6	15.2	15.7	15.9	13.4	14
16			16.5	14.5	16.6	17.5	15.6	17.1	17.5	16.5	15.5	13.5	14.0	14.1	12.4	16
18				11.3	13.3	14.4	12.4	13.8	15.0	13.3	14.4	12.2	12.6	12.7	12.0	18
20					10.8	12.1	10.0	11.4	12.5	10.9	11.9	11.1	11.4	11.5	10.8	20
22					6.9	10.4	8.2	9.5	10.6	9.0	10.0	10.0	9.5	10.3	9.5	22
24						6.8	6.7	8.0	9.0	7.5	8.5	9.3	8.0	8.8	8.4	24
26							4.2	6.7	7.8	6.2	7.2	8.2	6.8	7.5	7.1	26
28								4.5	6.7	5.2	6.2	7.1	5.7	6.5	6.1	28
30									3.3	4.4	5.3	6.2	4.9	5.6	5.2	30
32										2.1	4.6	5.5	4.1	4.9	4.5	32
34											3.9	4.8	3.5	4.2	3.8	34
36												4.2	2.9	3.7	3.2	36
38												2.1	2.4	3.2	2.7	38
40														2.7	2.3	40
42															1.9	42
44															1.6	44

*Requires special equipment

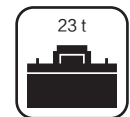

	12.9	17.5	19.9	22.2	24.5	26.8	29.1	31.5	33.8	36.1	38.4	40.7
	0°	0°	0°	0°	0°	0°	0°	0°	0°	0°	0°	0°
	10.4	15.1	17.4	19.7	22.0	24.3	26.6	29.0	31.3	33.6	36.0	38.0
	17.5	12.1	11.2	6.7	6.9	6.2	3.5	4.2	2.2	1.5	1.2	2.1

LOAD CHARTS

BOOM

ASME B30.5 85%

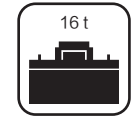
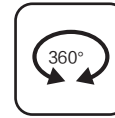

	12.9	17.5	19.9	22.2	24.5	26.8	29.1	31.5	33.8	36.1	38.4	40.7	43.0	45.4	50.0	
2.5	117*															2.5
3	110.0															3
4	85.0															4
5	70.0	70.0	39.2													5
6	58.5	58.5	40.3	55.0	37.5	39.2										6
7	49.0	49.0	41.3	47.5	38.6	40.0	37.0	30.1	28.0	31.0						7
8	42.5	42.2	42.1	40.3	39.1	37.5	37.0	30.5	26.3	30.5	22.5	20.6				8
9	37.0	35.7	37.1	34.1	36.5	35.2	35.0	28.0	24.7	27.5	21.6	19.8	19.5			9
10	25.0	29.9	33.0	29.4	32.0	33.1	31.0	26.5	23.4	27.6	20.4	18.7	18.9	17.4		10
12		20.3	23.1	19.9	22.2	24.1	21.6	22.4	21.2	22.7	18.5	17.2	17.3	17.0	13.9	12
14		14.7	17.2	14.3	16.5	18.1	15.9	17.4	18.7	16.8	16.6	15.2	15.7	15.9	13.4	14
16			13.4	10.7	12.6	14.2	12.1	13.5	14.7	13.0	14.1	13.5	13.6	14.1	12.4	16
18				8.0	9.9	11.5	9.4	10.8	11.9	10.3	11.3	12.2	10.8	11.7	11.2	18
20					7.9	9.4	7.4	8.7	9.8	8.2	9.2	10.2	8.8	9.6	9.1	20
22					5.0	7.8	5.9	7.2	8.2	6.6	7.6	8.6	7.2	8.0	7.5	22
24						4.8	4.6	5.9	6.9	5.4	6.4	7.3	5.9	6.7	6.3	24
26							2.5	4.9	5.9	4.4	5.3	6.2	4.9	5.6	5.2	26
28								3.1	5.0	3.5	4.5	5.4	4.0	4.8	4.3	28
30									2.9	2.7	3.7	4.6	3.3	4.0	3.6	30
32											3.1	4.0	2.7	3.4	3.0	32
34											2.5	3.4	1.9	2.9	2.4	34
36												3.0	1.4	2.4	1.9	36
38														1.9	1.4	38
40															1.0	40

*Requires special equipment

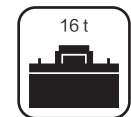

	12.9	17.5	19.9	22.2	24.5	26.8	29.1	31.5	33.8
	0°	0°	0°	0°	0°	0°	0°	0°	0°
	10.4	15.1	17.4	19.7	22.0	24.3	26.6	29.0	31.3
	15.5	9.9	9.3	4.3	5.0	4.5	2.2	2.9	1.6

JIB
ASME B30.5 85%

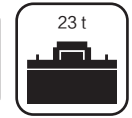
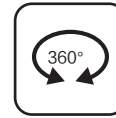

	50+10.8			
	0°	15°	30°	
16	6.2			16
18	6.1	5.3		18
20	6.0	5.1	3.5	20
22	6.0	5.1	3.3	22
24	5.4	4.9	3.2	24
26	4.6	4.6	3.1	26
28	4.0	4.2	3.0	28
30	3.4	3.6	2.9	30
32	3.0	3.2	2.7	32
34	2.5	2.7	2.6	34
36	2.2	2.3	2.5	36
38	1.9	2.0	2.2	38
40	1.6	1.7	1.8	40
42	1.4	1.4	1.5	42
44	1.1	1.3	1.3	44
46	0.9	1.0	1.1	46
48	0.7	0.8	0.9	48

LOAD CHARTS

JIB
ASME B30.5 85%

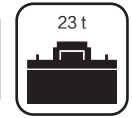
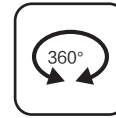

	50+18.3			
	0°	15°	30°	
18	3.0			18
20	3.1			20
22	3.1	2.4		22
24	3.1	2.2		24
26	3.1	2.1	1.6	26
28	2.9	2.0	1.5	28
30	2.8	1.9	1.4	30
32	2.7	1.8	1.3	32
34	2.6	1.7	1.2	34
36	2.4	1.6	1.2	36
38	2.2	1.5	1.1	38
40	1.8	1.4	1.1	40
42	1.6	1.4	1.0	42
44	1.4	1.3	1.1	44
46	1.2	1.2	1.0	46
48	1.0	1.2	1.0	48
50	0.8	1.0	1.0	50
52	0.6	0.8	0.9	52
54		0.7	0.8	54
56		0.5	0.6	56

JIB
ASME B30.5 85%

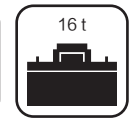

	50+10.8			
	0°	15°	30°	
16	6.2			16
18	6.1	5.3		18
20	5.9	5.1	3.5	20
22	5.0	5.1	3.3	22
24	4.1	4.5	3.2	24
26	3.5	3.8	3.1	26
28	2.9	3.2	3.0	28
30	2.4	2.7	2.9	30
32	2.1	2.3	2.4	32
34	1.7	1.9	2.1	34
36	1.4	1.5	1.7	36
38	1.2	1.3	1.4	38
40	0.9	1.0	1.2	40
42	0.7	0.8	0.9	42
44			0.7	44

LOAD CHARTS

JIB
ASME B30.5 85%

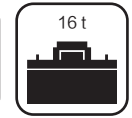
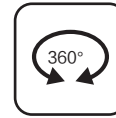

	50+18.3			
	0°	15°	30°	
18	3.0			18
20	3.1			20
22	3.1	2.4		22
24	3.1	2.2		24
26	3.1	2.1	1.6	26
28	2.9	2.0	1.5	28
30	2.7	1.9	1.4	30
32	2.3	1.8	1.3	32
34	2.0	1.7	1.2	34
36	1.6	1.6	1.2	36
38	1.4	1.5	1.1	38
40	1.2	1.4	1.1	40
42	0.9	1.2	1.0	42
44	0.7	1.0	1.1	44
46		0.7	0.9	46
48			0.7	48

BOOM

ASME B30.5 85%

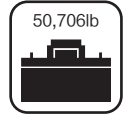

	42.3	57.4	65.3	72.8	80.4	87.9	95.5	103.3	110.9	118.4	126.0	133.5	141.1	148.9	164.0	
8.2	257938*															8.2
9.8	242506															9.8
13.1	198414															13.1
16.4	158731	154322	86420													16.4
19.7	132276	131174	88845	123458	82673	86420										19.7
23.0	114639	114639	91050	114639	85098	88184	81570	66358	61729	68343						23.0
26.2	100309	100309	93255	99207	86200	82673	81570	67240	57981	67240	49604	45415				26.2
29.5	85979	88845	88184	87302	88404	77602	77161	61729	54454	60627	47619	43651	42990			29.5
32.8	62831	77381	76720	76059	78263	72972	68343	58422	51588	60847	44974	41226	41667	38360		32.8
39.4		55776	60627	56438	62390	63272	59524	49383	46738	53792	40785	37919	38140	37478	30644	39.4
45.9		42108	46738	41887	46738	48722	44533	46958	42328	46517	36596	33510	34612	35053	29542	45.9
52.5			36376	31967	36596	38581	34392	37699	38581	36376	34171	29762	30864	31085	27337	52.5
59.1				24912	29321	31746	27337	30423	33069	29321	31746	26896	27778	27998	26455	59.1
65.6					23810	26676	22046	25132	27558	24030	26235	24471	25132	25353	23810	65.6
72.2					15212	22928	18078	20944	23369	19841	22046	22046	20944	22707	20944	72.2
78.7						14991	14771	17637	19841	16535	18739	20503	17637	19400	18519	78.7
85.3							9259	14771	17196	13669	15873	18078	14991	16535	15653	85.3
91.9								9921	14771	11464	13669	15653	12566	14330	13448	91.9
98.4									7275	9700	11684	13669	10803	12346	11464	98.4
105.0										4630	10141	12125	9039	10803	9921	105.0
111.5											8598	10582	7716	9259	8377	111.5
118.1												9259	6393	8157	7055	118.1
124.7												4630	5291	7055	5952	124.7
131.2														5952	5071	131.2
137.8															4189	137.8
144.4															3527	144.4

*Requires special equipment

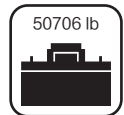
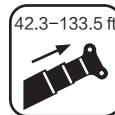

	42.3	57.4	65.3	72.8	80.4	87.9	95.5	103.3	110.9	118.4	126.0	133.5
	0°	0°	0°	0°	0°	0°	0°	0°	0°	0°	0°	0°
	34.1	49.5	57.1	64.6	72.3	79.8	87.4	95.2	102.8	110.3	118.1	124.7
	38581	26676	24692	14771	15212	13669	7716	9259	4850	3307	2646	4630

LOAD CHARTS

BOOM

ASME B30.5 85%

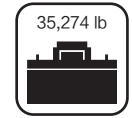
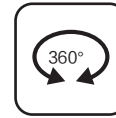
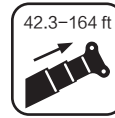

	42.3	57.4	65.3	72.8	80.4	87.9	95.5	103.3	110.9	118.4	126.0	133.5	141.1	148.9	164.0		
8.2	257938*															8.2	
9.8	242506															9.8	
13.1	187391															13.1	
16.4	154322	154322	86420													16.4	
19.7	128969	128969	88845	121253	82673	86420										19.7	
23.0	108025	108025	91050	104719	85098	88184	81570	66358	61729	68343						23.0	
26.2	93696	93034	92814	88845	86200	82673	81570	67240	57981	67240	49604	45415				26.2	
29.5	81570	78704	81791	75177	80468	77602	77161	61729	54454	60627	47619	43651	42990			29.5	
32.8	55115	65918	72752	64815	70547	72972	68343	58422	51588	60847	44974	41226	41667	38360		32.8	
39.4		44753	50926	43872	48942	53131	47619	49383	46738	50044	40785	37919	38140	37478	30644	39.4	
45.9		32408	37919	31526	36376	39903	35053	38360	41226	37037	36596	33510	34612	35053	29542	45.9	
52.5			29542	23589	27778	31305	26676	29762	32408	28660	31085	29762	29983	31085	27337	52.5	
59.1				17637	21826	25353	20723	23810	26235	22707	24912	26896	23810	25794	24692	59.1	
65.6					17416	20723	16314	19180	21605	18078	20282	22487	19400	21164	20062	65.6	
72.2					11023	17196	13007	15873	18078	14550	16755	18960	15873	17637	16535	72.2	
78.7						10582	10141	13007	15212	11905	14109	16094	13007	14771	13889	78.7	
85.3							5512	10803	13007	9700	11684	13669	10803	12346	11464	85.3	
91.9								6834	11023	7716	9921	11905	8818	10582	9480	91.9	
98.4									6393	5952	8157	10141	7275	8818	7937	98.4	
105.0											6834	8818	5952	7496	6614	105.0	
111.5												5512	7496	4189	6393	5291	111.5
118.1													6614	3086	5291	4189	118.1
124.7														4189	3086	124.7	
131.2															2205	131.2	

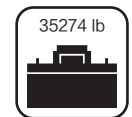

*Requires special equipment



	42.3	57.4	65.3	72.8	80.4	87.9	95.5	103.3	110.9
	0°	0°	0°	0°	0°	0°	0°	0°	0°
	34.1	49.5	57.1	64.6	72.3	79.8	87.4	95.2	102.8
	34171	21826	20503	9480	11023	9921	4850	6393	3527

JIB
ASME B30.5 85%



	164.0+35.4			
	0°	15°	30°	
52.5	13669			52.5
59.1	13448	11684		59.1
65.6	13228	11244	7716	65.6
72.2	13228	11244	7275	72.2
78.7	11905	10803	7055	78.7
85.3	10141	10141	6834	85.3
91.9	8818	9259	6614	91.9
98.4	7496	7937	6393	98.4
105.0	6614	7055	5952	105.0
111.5	5512	5952	5732	111.5
118.1	4850	5071	5512	118.1
124.7	4189	4409	4850	124.7
131.2	3527	3748	3968	131.2
137.8	3086	3086	3307	137.8
144.4	2425	2866	2866	144.4
150.9	1984	2205	2425	150.9
157.5	1543	1764	1984	157.5

LOAD CHARTS

JIB
ASME B30.5 85%

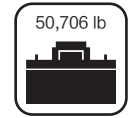
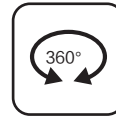

	164.0+60.0			
	0°	15°	30°	
59.1	6614			59.1
65.6	6834			65.6
72.2	6834	5291		72.2
78.7	6834	4850		78.7
85.3	6834	4630	3527	85.3
91.9	6393	4409	3307	91.9
98.4	6173	4189	3086	98.4
105.0	5952	3968	2866	105.0
111.5	5732	3748	2646	111.5
118.1	5291	3527	2646	118.1
124.7	4850	3307	2425	124.7
131.2	3968	3086	2425	131.2
137.8	3527	3086	2205	137.8
144.4	3086	2866	2425	144.4
150.9	2646	2646	2205	150.9
157.5	2205	2646	2205	157.5
164.0	1764	2205	2205	164.0
170.6	1323	1764	1984	170.6
177.2	1102	1543	1764	177.2
183.7		1102	1323	183.7

JIB
ASME B30.5 85%

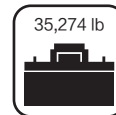

164.0+35.4



	164.0+35.4			
	0°	15°	30°	
52.5	13669			52.5
59.1	13448	11684		59.1
65.6	13007	11244	7716	65.6
72.2	11023	11244	7275	72.2
78.7	9039	9921	7055	78.7
85.3	7716	8378	6834	85.3
91.9	6393	7055	6614	91.9
98.4	5291	5952	6393	98.4
105.0	4630	5071	5291	105.0
111.5	3748	4189	4630	111.5
118.1	3086	3307	3748	118.1
124.7	2646	2866	3086	124.7
131.2	1984	2205	2646	131.2
137.8	1543	1764	1984	137.8
144.4			1543	144.4

LOAD CHARTS

JIB
ASME B30.5 85%

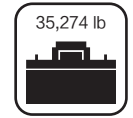
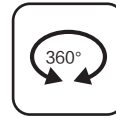

	164.0+60.0			
	0°	15°	30°	
59.1	6614			59.1
65.6	6834			65.6
72.2	6834	5291		72.2
78.7	6834	4850		78.7
85.3	6834	4630	3527	85.3
91.9	6393	4409	3307	91.9
98.4	5952	4189	3086	98.4
105.0	5071	3968	2866	105.0
111.5	4409	3748	2646	111.5
118.1	3527	3527	2646	118.1
124.7	3086	3307	2425	124.7
131.2	2646	3086	2425	131.2
137.8	1984	2646	2205	137.8
144.4	1543	2205	2425	144.4
150.9		1543	1984	150.9
157.5			1543	157.5